

Data Sheet



Article number: 04H081903000250V2

Description: Stabilus IndustryLine stainless steel gas spring size 08/19
250N length 645mm, stroke 300mm Type 04H0819250

Measures

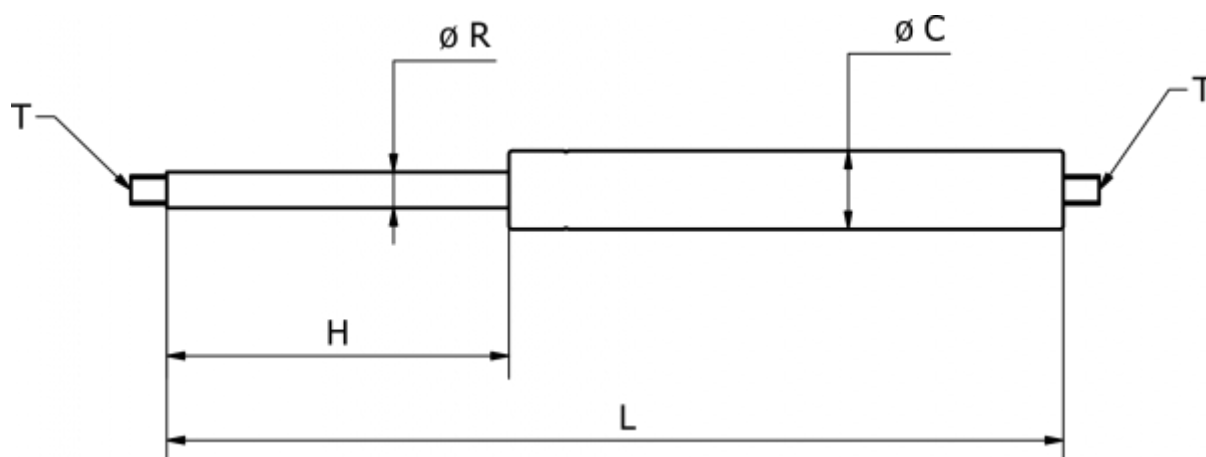

C = 19

H = 300

L = 645

R = 8

T = M8 x 10